

Advanced Data Sheet

VFHY107-010

90 Degree Hybrid

3.0 – 4.0 GHz



Features

- Highly repeatable monolithic design
- Very low insertion loss
- High Isolation / Low VSWR
- Excellent phase & amplitude balance
- Power handling: 4 Watts
- Miniature 1.5 x 2.0 mm package

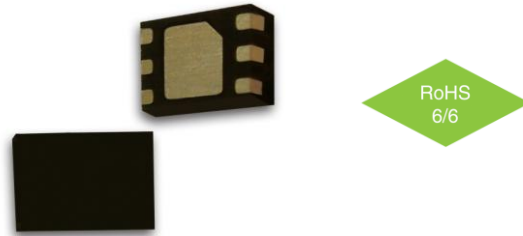

Applications

- Phase shifter / Attenuator
- Balanced amplifier / LNA configurations
- Modulators
- Mixers
- Power combining /dividing

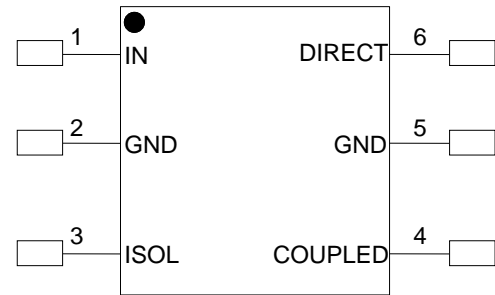

TOP VIEW

Description

The **VFHY107-010** is a miniature high performance 90 degree hybrid optimized for the 3300 – 3800 MHz band as specified below. The device will also exhibit good performance and can be used in applications over the broader frequency range of 3.0 – 4.0 GHz. The **VFHY107-010** is offered in an easy to use 1.5 x 2.0 mm surface mount leadless package and comes available in tape and reel. The **VFHY107-010** is a fully passive monolithic device that offers very low insertion loss, high isolation, low VSWR and excellent phase and amplitude balance.

Electrical Specifications at 25° C

Parameter	Symbol	Min	Typ	Max	Unit
Frequency Range	F	3300		3800	MHz
Insertion Loss (Above 3dB)	I_L		0.35		dB
Isolation	Isol		30		dB
Phase balance	\varnothing_{bal}		+/- 1.0		deg
Amplitude balance	A_{bal}		+/- 0.5		dB
VSWR all Ports			1.1	1.2	:1



Advanced Data Sheet
VFHY107-010
90 Degree Hybrid
3.0 – 4.0 GHz



Simulation Data

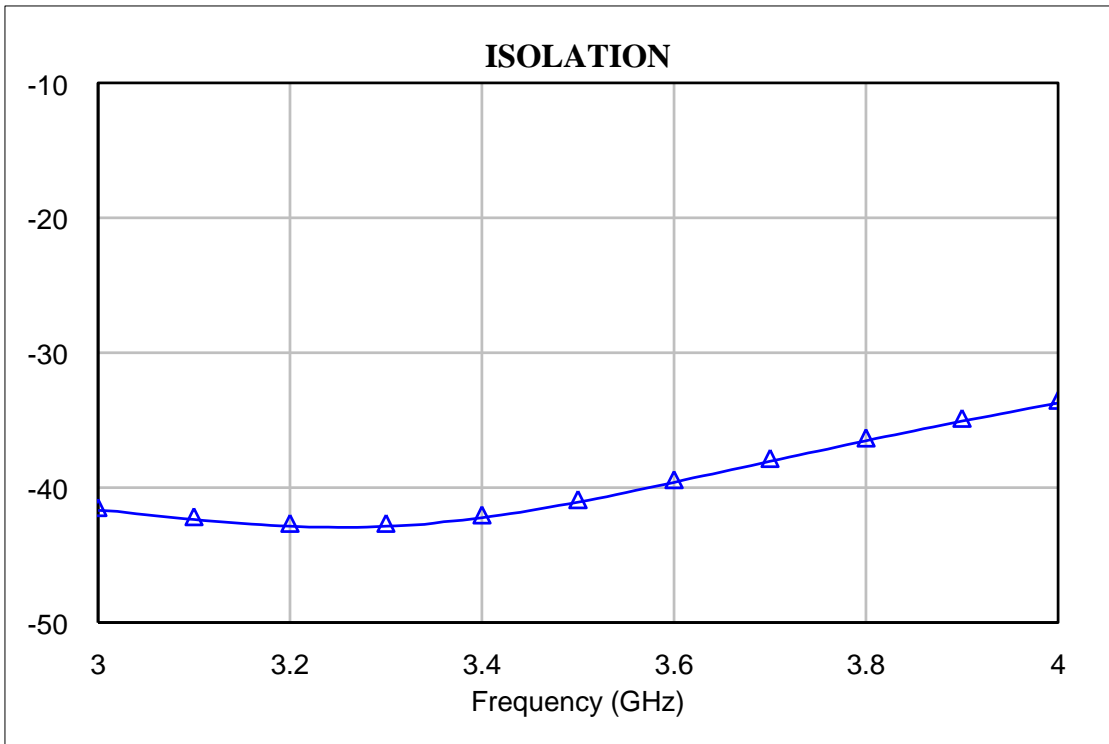
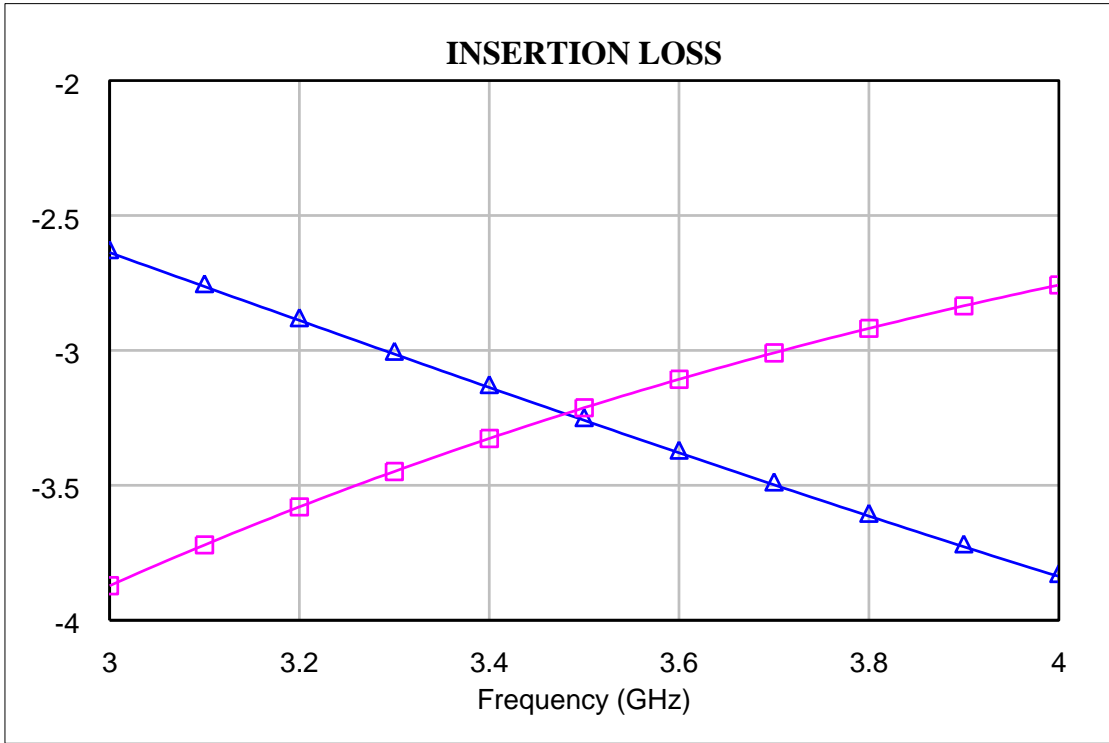

Advanced Data Sheet
VFHY107-010
90 Degree Hybrid
3.0 – 4.0 GHz



Simulation Data

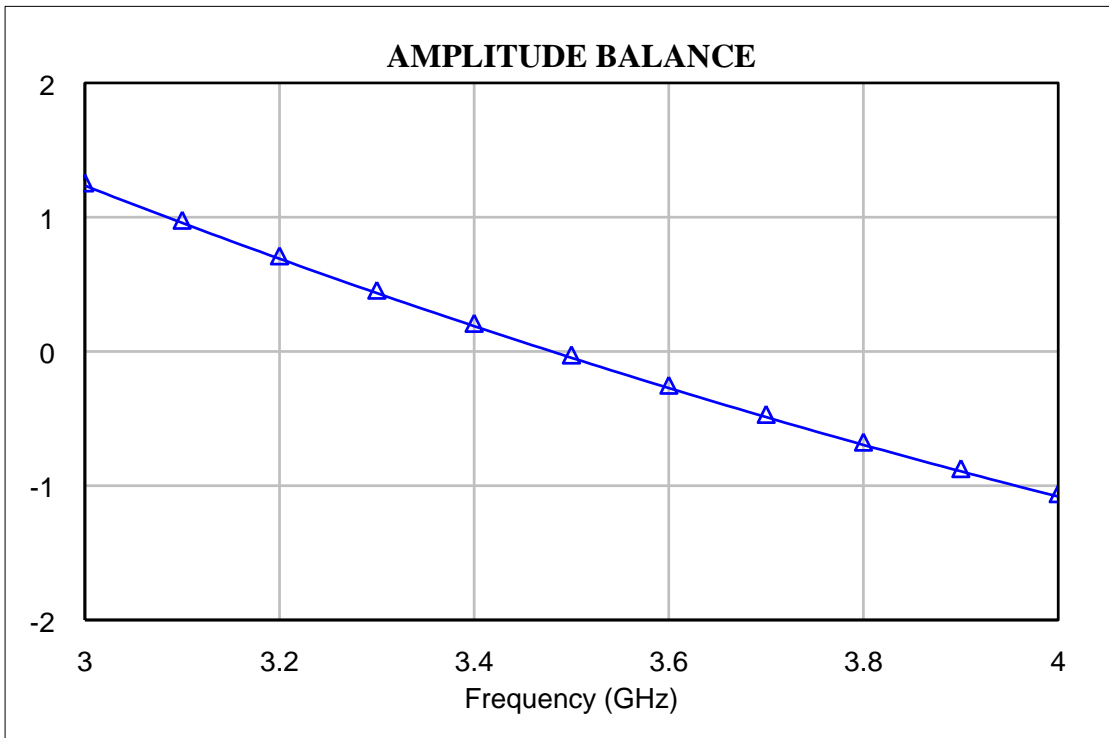
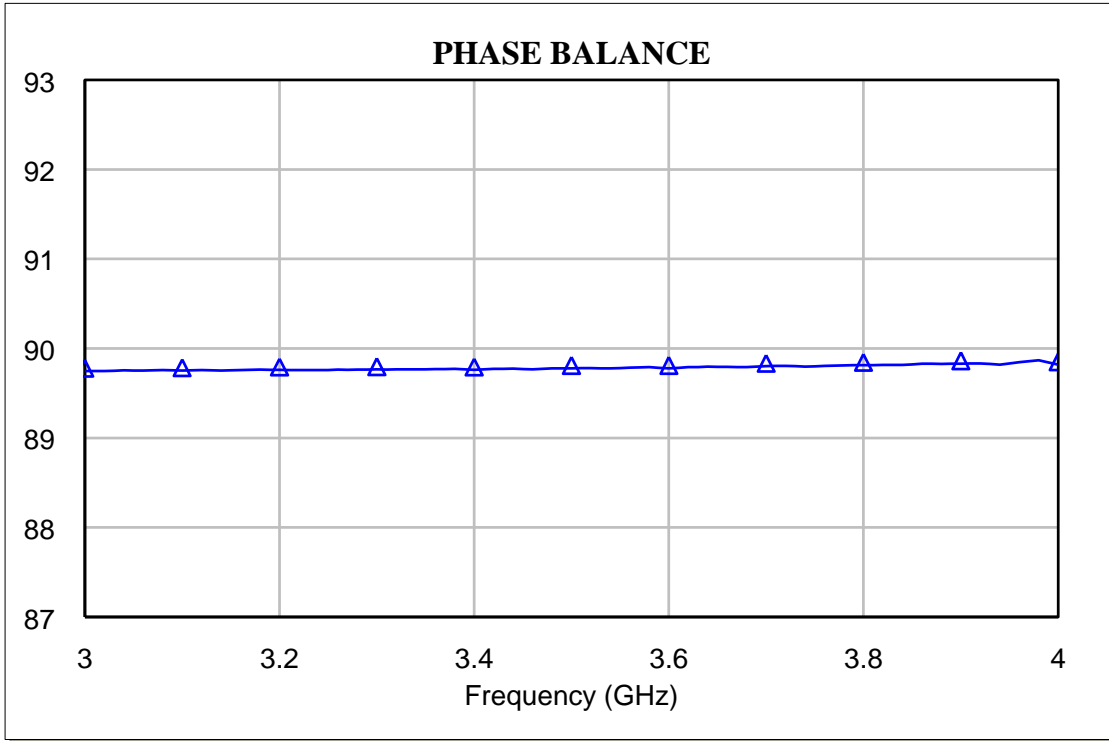

Advanced Data Sheet
VFHY107-010
90 Degree Hybrid
3.0 – 4.0 GHz



Simulation Data

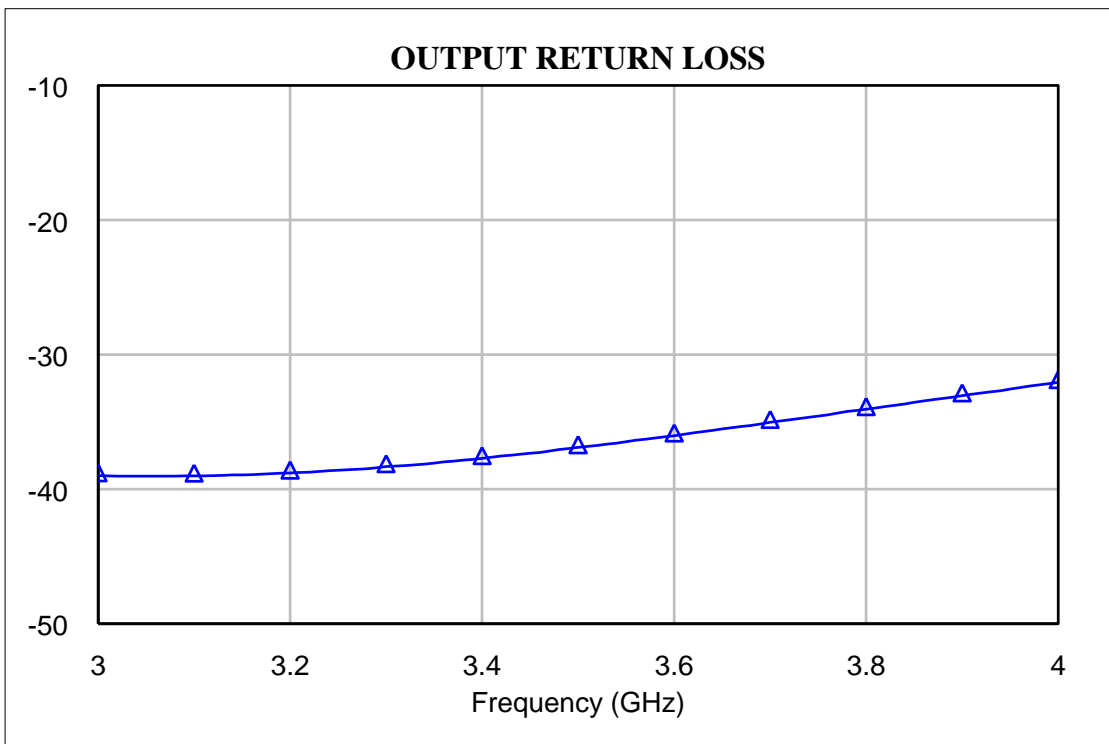
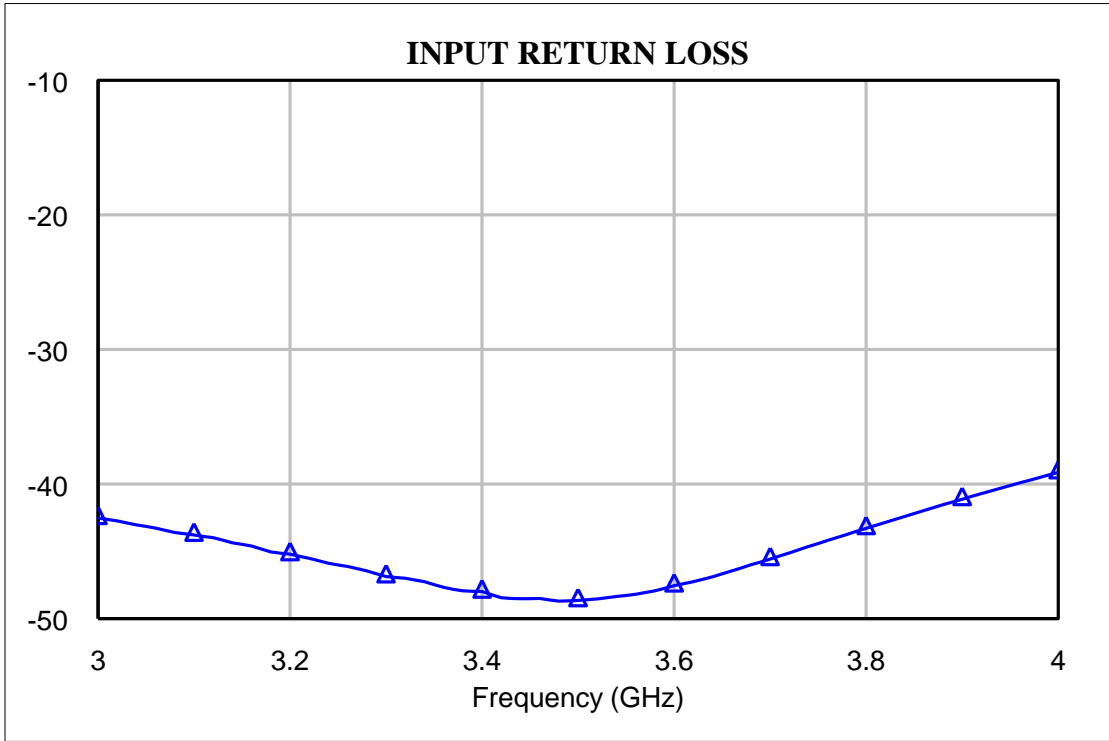

Advanced Data Sheet

VFHY107-010

90 Degree Hybrid

3.0 – 4.0 GHz



Absolute Maximum Ratings

Parameter	Specifications
Operating Temperature	-40°C to +85°C
Storage Temperature	-65°C to +150°C
Power Handling	4W

Outline Drawing

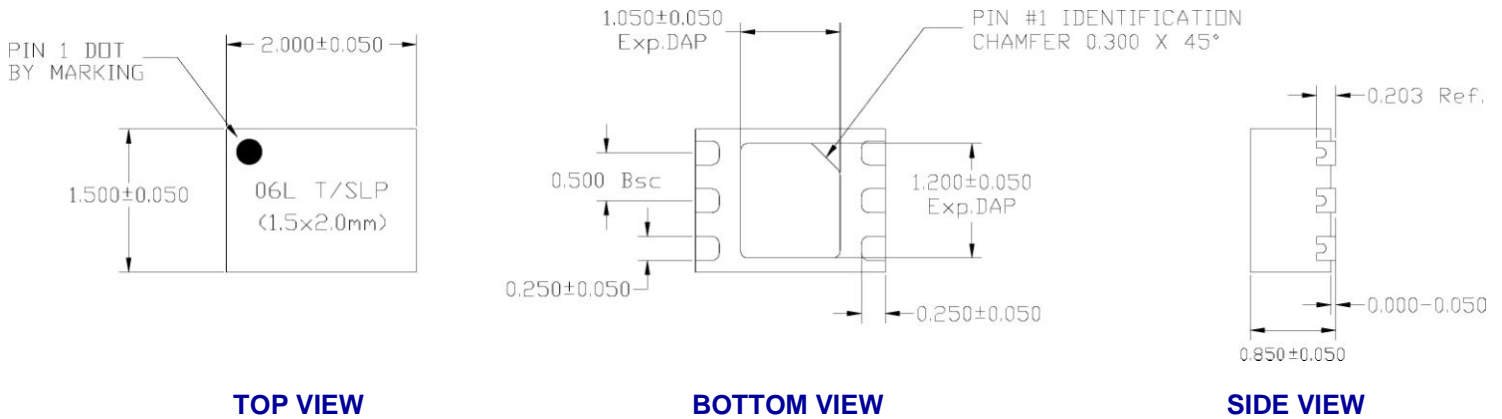

Land Pattern

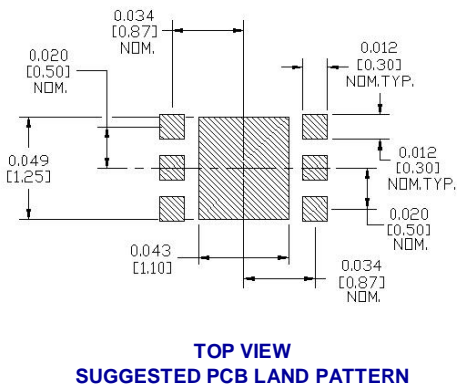

Pin Out

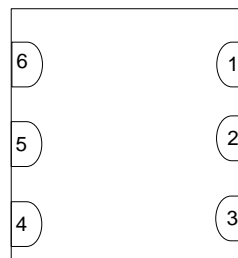

Pin #	Connection
1	IN
2	GND
3	ISOLATED
4	COUPLED
5	GND
6	DIRECT

